

## REPETITIVE AVALANCHE AND $dv/dt$ RATED HEXFET<sup>®</sup> TRANSISTORS THRU-HOLE (TO-204AA/AE)

## IRF9140 100V, P-CHANNEL

### Product Summary

Part Number	BVDSS	RDS(on)	ID
IRF9140	-100V	0.2Ω	-18A



The HEXFET<sup>®</sup> technology is the key to International Rectifier's advanced line of power MOSFET transistors. The efficient geometry and unique processing of this latest "State of the Art" design achieves: very low on-state resistance combined with high transconductance; superior reverse energy and diode recovery  $dv/dt$  capability.

The HEXFET transistors also feature all of the well established advantages of MOSFETs such as voltage control, very fast switching, ease of paralleling and temperature stability of the electrical parameters.

They are well suited for applications such as switching power supplies, motor controls, inverters, choppers, audio amplifiers and high energy pulse circuits.

### Features:

- Repetitive Avalanche Ratings
- Dynamic  $dv/dt$  Rating
- Hermetically Sealed
- Simple Drive Requirements
- Ease of Paralleling

### Absolute Maximum Ratings

	Parameter		Units
$I_D$ @ $V_{GS} = 0V, T_C = 25^\circ C$	Continuous Drain Current	-18	A
$I_D$ @ $V_{GS} = 0V, T_C = 100^\circ C$	Continuous Drain Current	-11	
$I_{DM}$	Pulsed Drain Current ①	-72	
$P_D$ @ $T_C = 25^\circ C$	Max. Power Dissipation	125	W
	Linear Derating Factor	1.0	W/ $^\circ C$
$V_{GS}$	Gate-to-Source Voltage	$\pm 20$	V
$E_{AS}$	Single Pulse Avalanche Energy ②	500	mJ
$I_{AR}$	Avalanche Current ①	-18	A
$E_{AR}$	Repetitive Avalanche Energy ①	12.5	mJ
$dv/dt$	Peak Diode Recovery $dv/dt$ ③	-5.5	V/ns
$T_J$	Operating Junction	-55 to 150	$^\circ C$
$T_{STG}$	Storage Temperature Range		
	Lead Temperature	300 (0.063 in. (1.6mm) from case for 10s)	
	Weight	11.5(typical)	g

For footnotes refer to the last page

**Electrical Characteristics @ Tj = 25°C (Unless Otherwise Specified)**

	Parameter	Min	Typ	Max	Units	Test Conditions
BVDSS	Drain-to-Source Breakdown Voltage	-100	—	—	V	VGS = 0V, ID = -1.0mA
ΔBVDSS/ΔTj	Temperature Coefficient of Breakdown Voltage	—	-0.087	—	V/°C	Reference to 25°C, ID = -1.0mA
RDS(on)	Static Drain-to-Source On-State Resistance	—	—	0.2	Ω	VGS = -10V, ID = -11A ④
		—	—	0.23		VGS = -10V, ID = -18A ④
VGS(th)	Gate Threshold Voltage	-2.0	—	-4.0	V	VDS = VGS, ID = -250μA
gfs	Forward Transconductance	6.2	—	—	S (r)	VDS > -15V, IDS = -11A ④
IDSS	Zero Gate Voltage Drain Current	—	—	-25	μA	VDS = -80V, VGS = 0V
		—	—	-250		VDS = -80V VGS = 0V, Tj = 125°C
IGSS	Gate-to-Source Leakage Forward	—	—	-100	nA	VGS = -20V
IGSS	Gate-to-Source Leakage Reverse	—	—	100		VGS = 20V
Qg	Total Gate Charge	31	—	60	nC	VGS = -10V, ID = -18A VDS = -50V
Qgs	Gate-to-Source Charge	3.7	—	13		
Qgd	Gate-to-Drain ('Miller') Charge	7.0	—	35.2		
td(on)	Turn-On Delay Time	—	—	35	ns	VDD = -50V, ID = -18A, RG = 9.1Ω
tr	Rise Time	—	—	85		
td(off)	Turn-Off Delay Time	—	—	85		
tf	Fall Time	—	—	65	nH	Measured from drain lead (6mm/0.25in. from package) to source lead (6mm/0.25in. from package)
LS + LD	Total Inductance	—	6.1	—		
Ciss	Input Capacitance	—	1400	—	pF	VGS = 0V, VDS = -25V f = 1.0MHz
Coss	Output Capacitance	—	600	—		
Crss	Reverse Transfer Capacitance	—	200	—		

**Source-Drain Diode Ratings and Characteristics**

	Parameter	Min	Typ	Max	Units	Test Conditions
IS	Continuous Source Current (Body Diode)	—	—	-18	A	
ISM	Pulse Source Current (Body Diode) ①	—	—	-72		
VSD	Diode Forward Voltage	—	—	-4.2	V	Tj = 25°C, IS = -18A, VGS = 0V ④
trr	Reverse Recovery Time	—	170	280	nS	Tj = 25°C, IF = -18A, di/dt ≤ -100A/μs
QRR	Reverse Recovery Charge	—	—	3.6	μC	VDD ≤ -50V ④
ton	Forward Turn-On Time	Intrinsic turn-on time is negligible. Turn-on speed is substantially controlled by LS + LD.				

**Thermal Resistance**

	Parameter	Min	Typ	Max	Units	Test Conditions
RthJC	Junction-to-Case	—	—	1.0	°C/W	Soldered to a 2" square copper-clad board
RthJA	Junction-to-Ambient	—	—	30		

**Note: Corresponding Spice and Saber models are available on the G&S Website.**  
 For footnotes refer to the last page

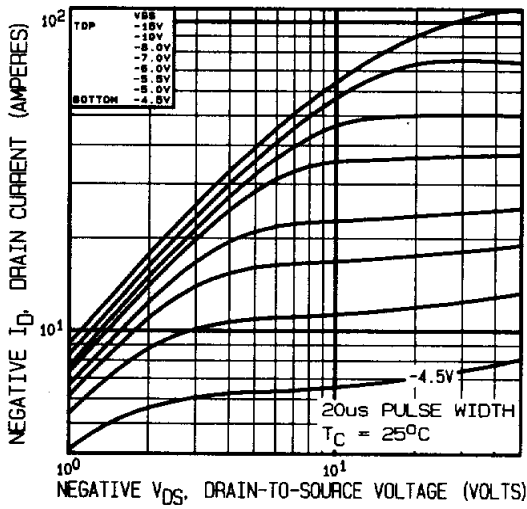

Fig 1. Typical Output Characteristics

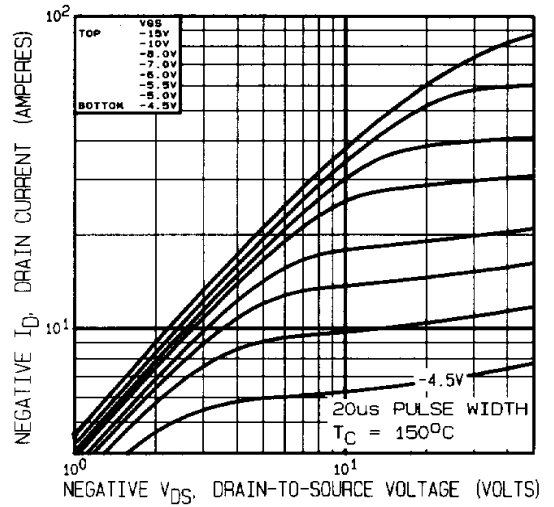

Fig 2. Typical Output Characteristics

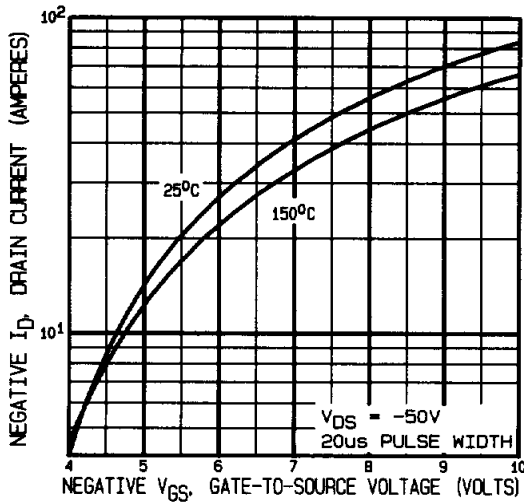

Fig 3. Typical Transfer Characteristics

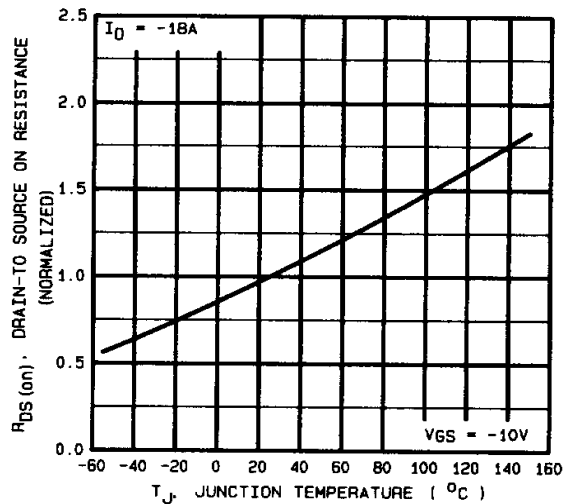
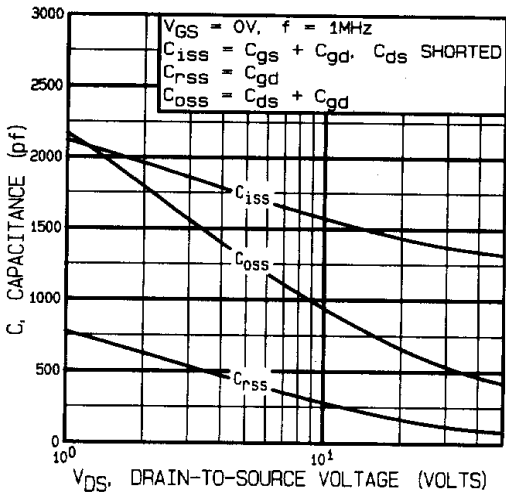
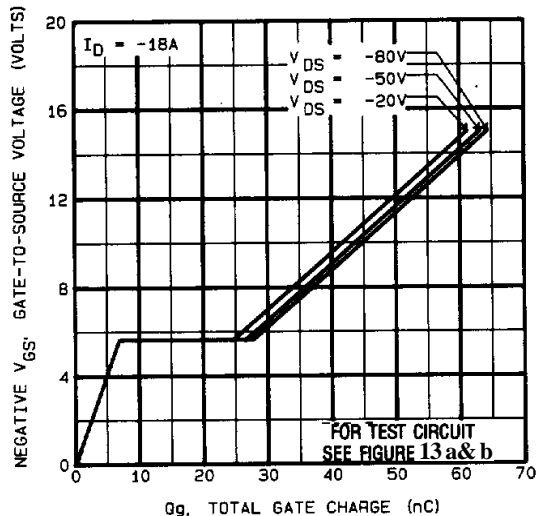

Fig 4. Normalized On-Resistance Vs. Temperature



**Fig 5.** Typical Capacitance Vs. Drain-to-Source Voltage



**Fig 6.** Typical Gate Charge Vs. Gate-to-Source Voltage

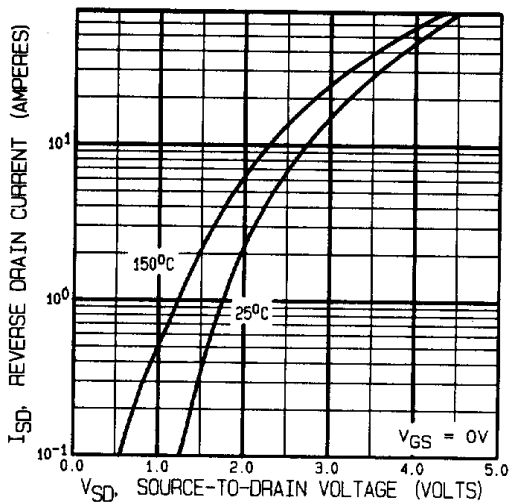

**Fig 7.** Typical Source-Drain Diode Forward Voltage

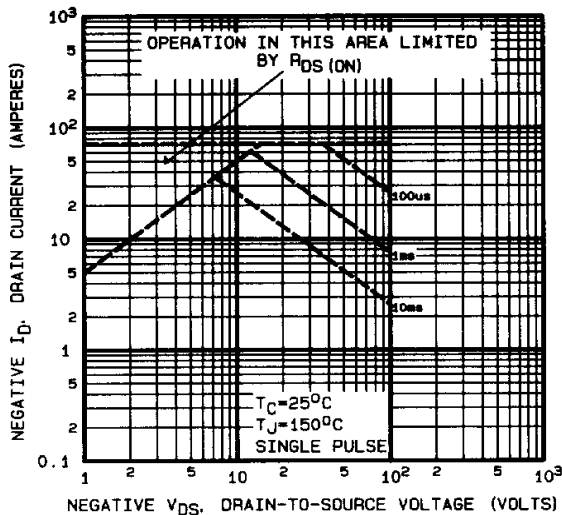

**Fig 8.** Maximum Safe Operating Area

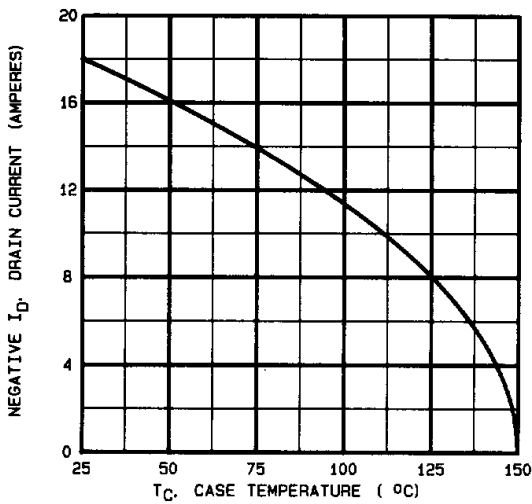

Fig 9. Maximum Drain Current Vs. Case Temperature

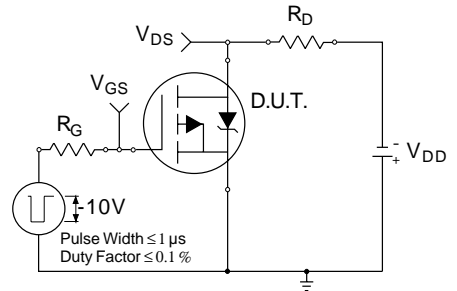

Fig 10a. Switching Time Test Circuit

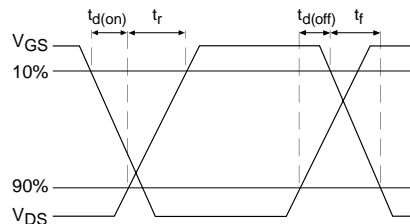

Fig 10b. Switching Time Waveforms

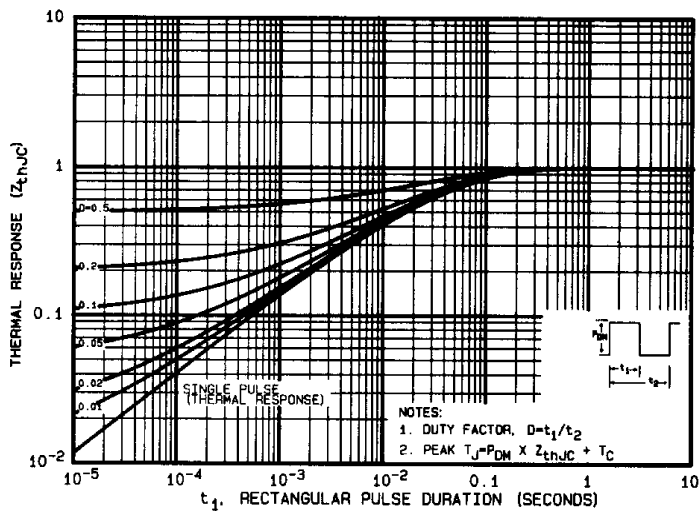

Fig 11. Maximum Effective Transient Thermal Impedance, Junction-to-Case

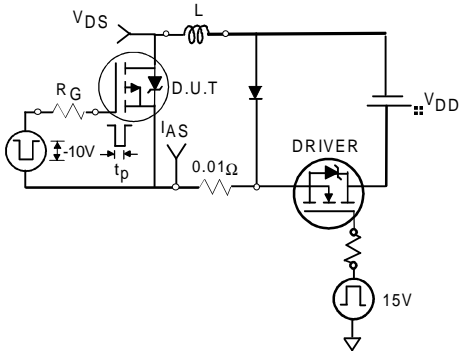

Fig 12a. Unclamped Inductive Test Circuit

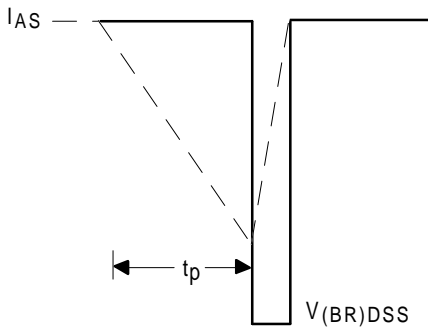

Fig 12b. Unclamped Inductive Waveforms

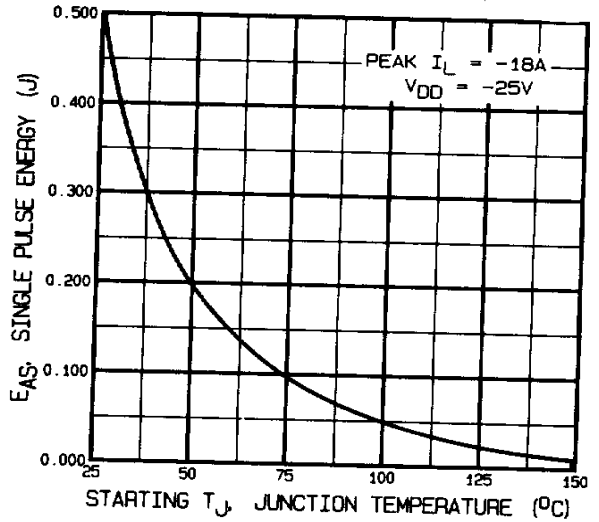

Fig 12c. Maximum Avalanche Energy Vs. Drain Current

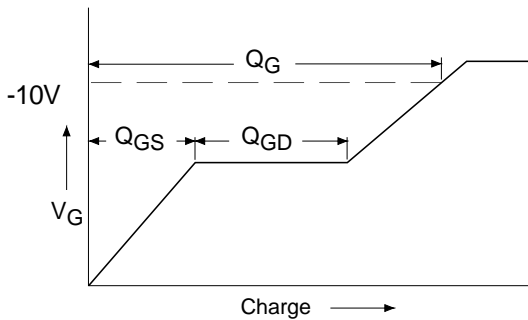

Fig 13a. Basic Gate Charge Waveform

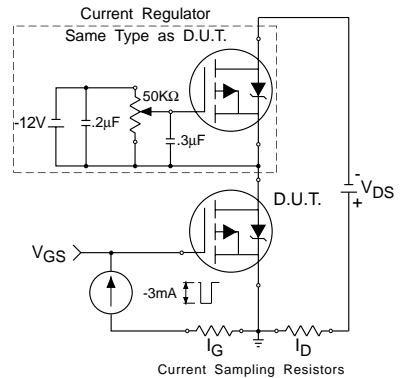
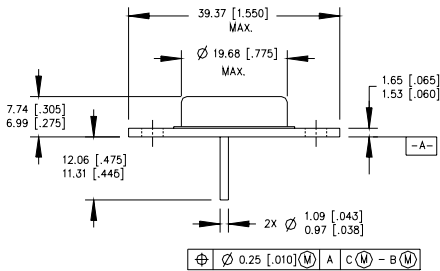

Fig 13b. Gate Charge Test Circuit

**Foot Notes:**

- ① Repetitive Rating; Pulse width limited by maximum junction temperature.
- ②  $V_{DD} = -25V$ , starting  $T_J = 25^\circ C$ ,  
Peak  $I_L = -18A$ ,
- ③  $I_{SD} \leq -18A$ ,  $di/dt \leq -100A/\mu s$ ,  
 $V_{DD} \leq -100V$ ,  $T_J \leq 150^\circ C$   
Suggested  $R_G = 9.1 \Omega$
- ④ Pulse width  $\leq 300 \mu s$ ; Duty Cycle  $\leq 2\%$

**Case Outline and Dimensions —TO-204AA (Modified TO-3)**



PIN ASSIGNMENTS

HEXFET	SCHOTTKY	IGBT
1 - SOURCE	1 - ANODE 1	1 - GATE
2 - GATE	2 - ANODE 2	2 - EMITTER
3 - DRAIN (CASE)	3 - COMMON CATHODE (CASE)	3 - COLLECTOR (CASE)

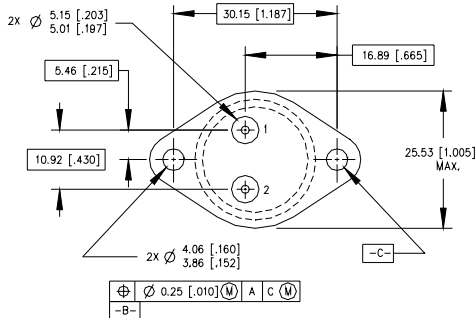

NOTES:

1. DIMENSIONING & TOLERANCING PER ANSI Y14.5M-1982.
2. CONTROLLING DIMENSION : INCH.
3. DIMENSIONS ARE SHOWN IN MILLIMETERS [INCHES].
4. OUTLINE CONFORMS TO JEDEC OUTLINE TO-204-AA.